

**CONNECTOR
 DESIGNATORS
 A-F-H-L-S
 SELF-LOCKING
 ROTATABLE
 COUPLING
 TYPE F INDIVIDUAL
 AND/OR OVERALL
 SHIELD TERMINATION**

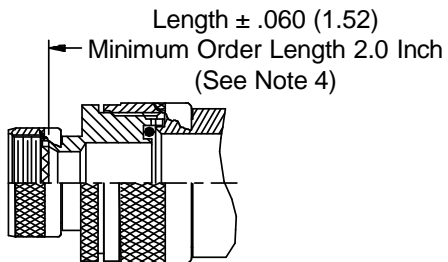

**STYLE 2
 (STRAIGHT
 See Note 1)**

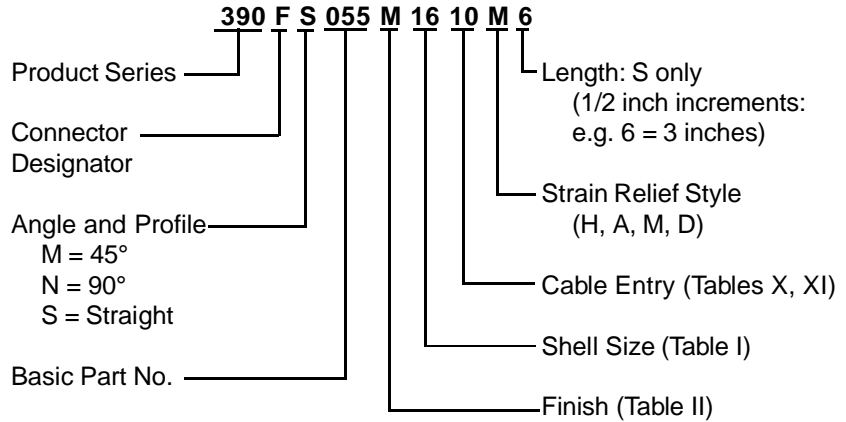
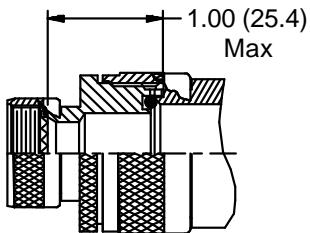

**STYLE 2
 (45° & 90°
 See Note 1)**

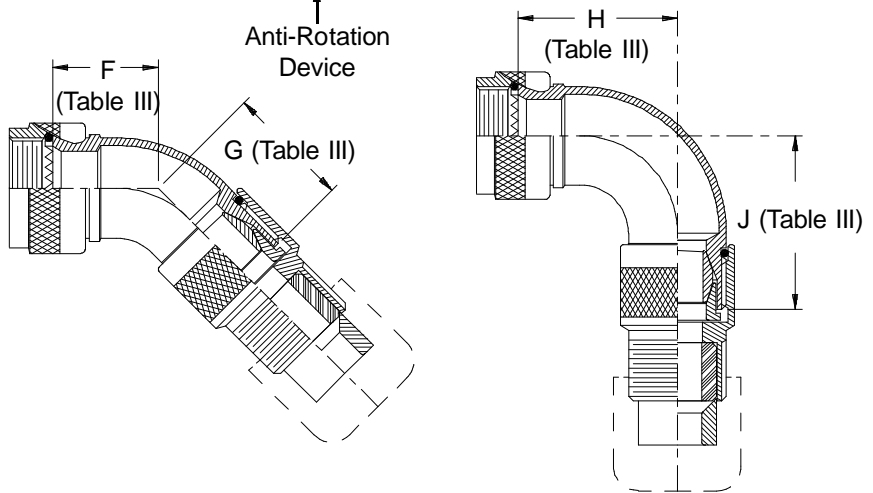
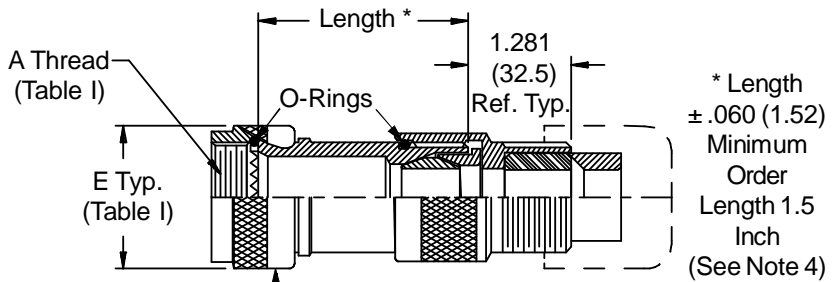

**STYLE H
 Heavy Duty
 (Table X)**

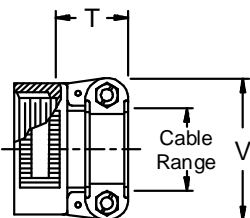

**STYLE A
 Medium Duty
 (Table XI)**

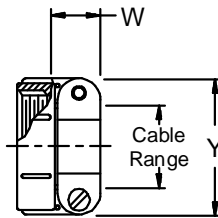

**STYLE M
 Medium Duty
 (Table XI)**

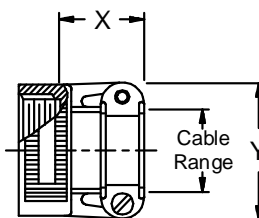

**STYLE D
 Medium Duty
 (Table XI)**

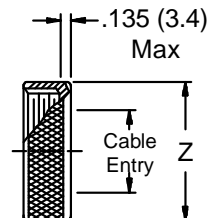

390-055
Submersible EMI/RFI Cable Sealing Backshell
 with Strain Relief
 Type F - Self-Locking Rotatable Coupling - Full Radius Profile



TABLE III: ELBOW DIMENSIONS

Shell Size		F	G	H	J
Conn. Desig.	A-F-L-S H	Max	Max	Max	Max
08		.968 (24.6)	1.095 (27.8)	1.281 (32.5)	1.287 (32.7)
10	11	1.031 (26.2)	1.145 (29.1)	1.406 (35.7)	1.411 (35.8)
12		1.094 (27.8)	1.195 (30.4)	1.531 (38.9)	1.537 (39.0)
14	15	1.156 (29.4)	1.245 (31.6)	1.656 (42.1)	1.761 (44.7)
16		1.218 (30.9)	1.300 (33.0)	1.781 (45.2)	1.787 (45.4)
18	19	1.250 (31.8)	1.350 (34.3)	1.906 (48.4)	1.911 (48.5)
20		1.312 (33.3)	1.400 (35.6)	2.031 (51.6)	2.037 (51.7)
22	23	1.344 (34.1)	1.455 (37.0)	2.156 (54.8)	2.161 (54.9)
24		1.406 (35.7)	1.505 (38.1)	2.281 (57.9)	2.287 (58.1)
28		1.594 (40.5)	1.594 (10.5)	2.594 (65.9)	2.594 (65.9)

See inside back cover fold-out or pages 13 and 14 for Tables I and II.

TABLE X: CABLE ENTRY

Dash No.	T Max	V Max	Cable Range	
			Min	Max
04	.780 (19.8)	.957 (24.3)	.125 (3.2)	.312 (7.9)
06	.780 (19.8)	1.145 (29.1)	.250 (6.4)	.437 (11.1)
08	.780 (19.8)	1.332 (33.8)	.387 (9.3)	.562 (14.3)
10	.780 (19.8)	1.332 (33.8)	.350 (8.9)	.625 (15.9)
12	.811 (20.6)	1.551 (39.4)	.500 (12.7)	.750 (19.1)
16	.905 (23.0)	1.770 (45.0)	.625 (15.9)	.937 (23.8)
20	1.092 (27.7)	2.113 (53.7)	.875 (22.2)	1.250 (31.8)
24	1.124 (28.5)	2.363 (60.0)	1.000 (25.4)	1.375 (34.9)
28	1.399 (35.5)	2.770 (70.4)	1.250 (31.8)	1.625 (41.3)
32	1.399 (35.5)	3.020 (76.7)	1.437 (36.5)	1.875 (47.6)

- When maximum cable entry (page 21) is exceeded, Style 2 will be supplied. Dimensions F, G, H and J will not apply. Please consult factory.
- Metric dimensions (mm) are indicated in parentheses.
- Cable range is defined as the accommodations range for the wire bundle or cable. Dimensions shown are not intended for inspection criteria.
- Consult factory for shorter lengths on straight backshells.
- Interface O-Ring not supplied with connector designator A.

TABLE XI: CABLE ENTRY

Dash No.	W Max	X Max	Y Max	Z Max	Cable Range	
					Min **	Max
03*	.437 (11.1)	.760 (19.3)	.843 (21.4)	.630 (16.0)	.156 (4.0)	.250 (6.4)
04*	.437 (11.1)	.760 (19.3)	.906 (23.0)	.755 (19.2)	.188 (4.8)	.312 (7.9)
06*	.500 (12.7)	.760 (19.3)	1.093 (27.8)	.942 (23.9)	.281 (7.1)	.438 (11.1)
08	.563 (14.3)	.760 (19.3)	1.187 (30.1)	1.067 (27.1)	.387 (9.3)	.562 (14.3)
10	.563 (14.3)	.760 (19.3)	1.281 (32.5)	1.192 (30.3)	.375 (9.5)	.625 (15.9)
12	.563 (14.3)	.760 (19.3)	1.500 (38.1)	1.380 (35.1)	.438 (11.1)	.750 (19.1)
16	.656 (16.7)	1.073 (27.3)	1.719 (43.7)	1.535 (39.0)	.625 (15.9)	.938 (23.8)
20	.656 (16.7)	1.323 (33.6)	2.062 (52.4)	1.848 (46.9)	.875 (22.2)	1.250 (31.8)
24	.656 (16.7)	1.323 (33.6)	2.312 (58.7)	2.255 (57.3)	1.000 (25.4)	1.375 (34.9)
28	1.188 (30.2)	1.572 (39.9)	2.719 (69.1)	2.505 (63.6)	1.250 (31.8)	1.625 (41.3)
32*	1.187 (30.1)	1.572 (39.9)	2.969 (75.4)	2.755 (70.0)	1.437 (36.5)	1.875 (47.6)
40*	1.125 (28.6)	1.572 (39.9)	3.531 (89.7)	3.255 (82.7)	1.875 (47.6)	2.375 (60.3)

* Not available in Style M clamp. ** Not Applicable Style D